

The background is a detailed architectural floor plan in light blue lines on a white background. It shows various rooms, corridors, and furniture layouts. Notable features include a circular dining table with chairs in the upper left, a larger irregularly shaped table with chairs in the center, and several rectangular tables with chairs in the lower left. Dimensions and grid lines are visible throughout the plan.

U N I Q U E

BY

hidrobox®

SPECIAL SHOWER TRAYS. THE FREEDOM TO DESIGN AN INDIVIDUALISED SOLUTION

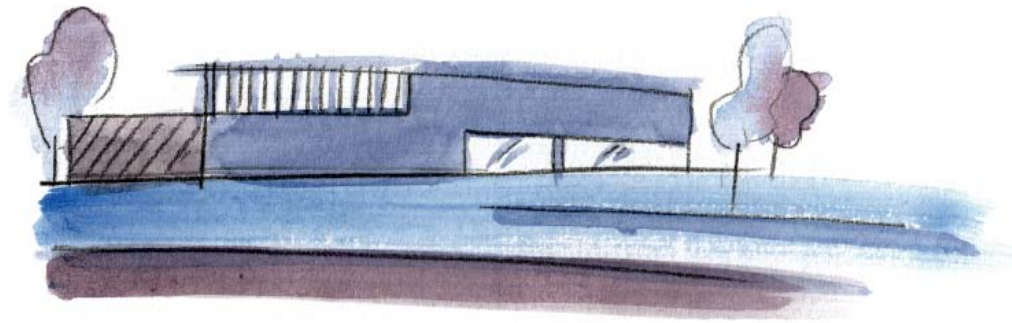

UNIQUE

ES

La **serie Unique** está desarrollada para ofrecer soluciones de nivel individualizado a cada espacio de ducha.

Encontramos la libertad de definir la forma para un espacio determinado y además de poder recurrir a diferentes tipologías y posiciones de desaguado. Este concepto permite reunir el mejor resultado en estética y funcionalidad para ofrecerle al usuario la más satisfactoria experiencia de ducha.

Unique es una solución para el diseñador de la estancia de ducha, respaldada por especialistas en el producto, que permite alcanzar la máxima individualización.

UNIQUE

EN

The **Unique series** has been developed to offer solutions, on an individualized basis, to each shower area.

We find the freedom to define the form of a given area alongside the ability to call upon different drainage types and positions. The concept allows for the best possible aesthetic and functional results to be brought together, with the aim of being able to offer the customer the most satisfactory shower experience available.

Unique is a solution for the shower area designer, backed up by product specialists, which allows for a maximum level of individualization to be achieved.

UNIQUE

FR

La **série Unique** a été développée dans le but de proposer une solution individuelle pour chaque espace douche.

Nous retrouvons la liberté de définir la forme pour une zone déterminée mais aussi la possibilité d'utiliser différents types d'évacuation, les positionnant, de plus, où vous le souhaitez sur le receveur. Ce concept permet l'union d'un résultat esthétique parfait et d'une fonctionnalité offrant à l'utilisateur une expérience de douche exclusive.

Unique est la solution pour le concepteur de la zone de douche, soutenu par des spécialistes du produit, accédant ainsi à une individualisation totale.

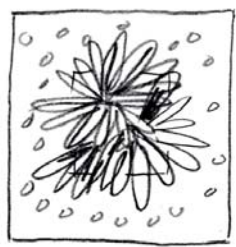

living room

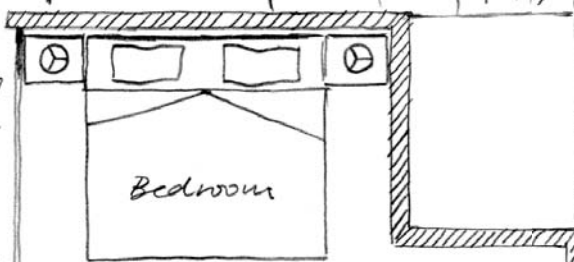
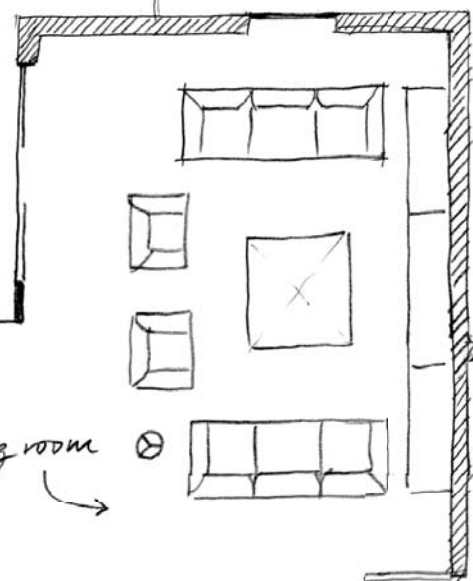

Private Area



4 m. long solution??

Upstairs



main entrance

garden area (2)

Solarium

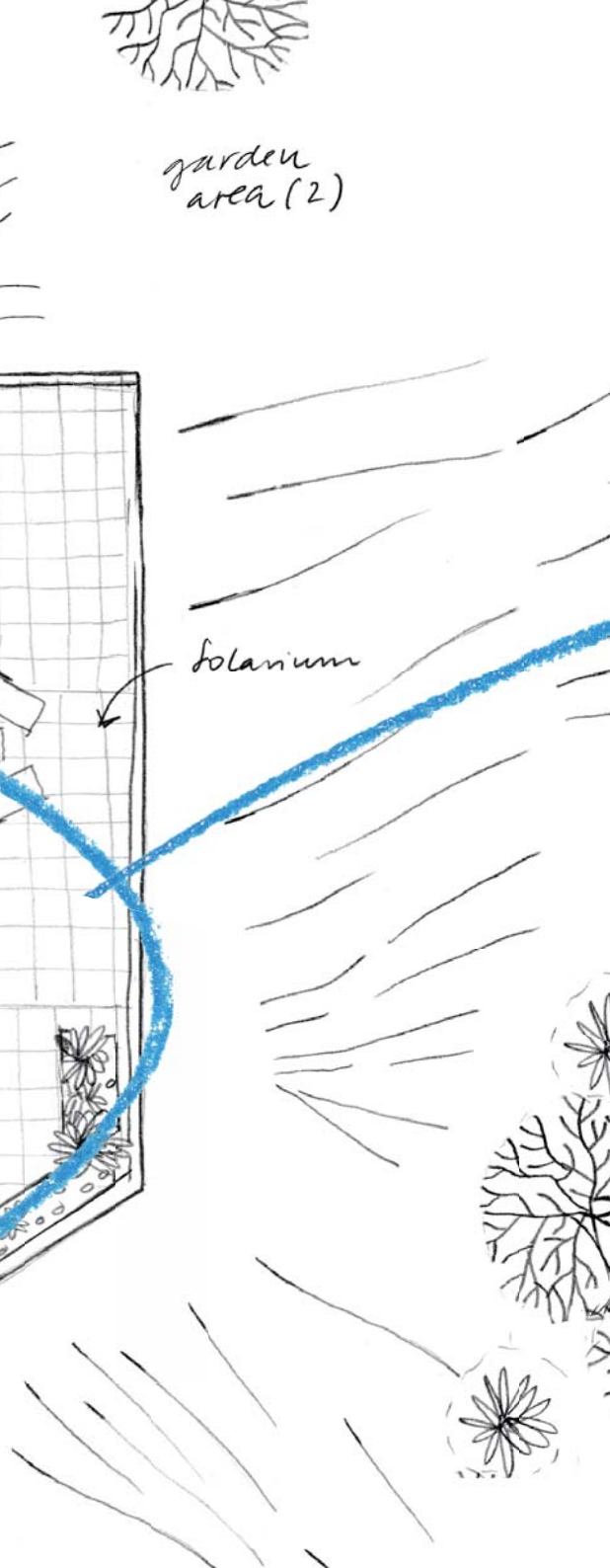
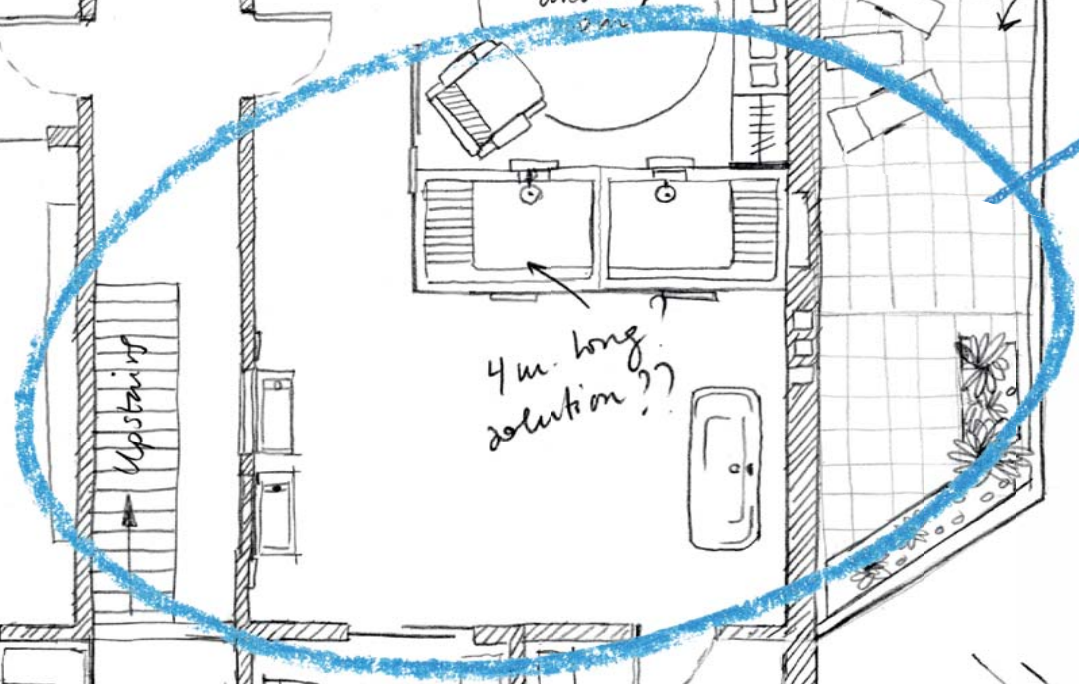
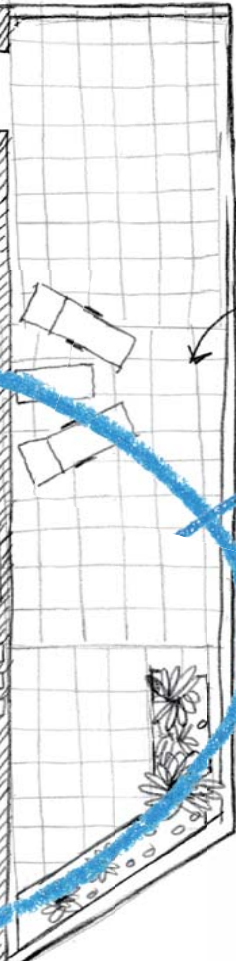
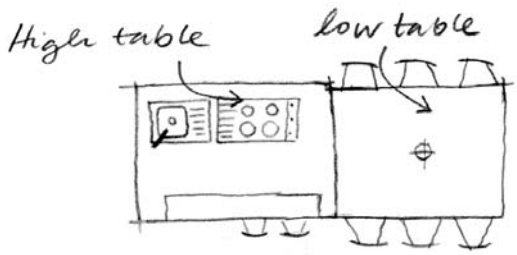

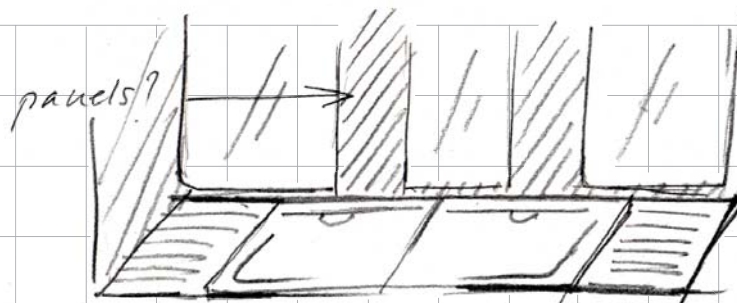

panels?

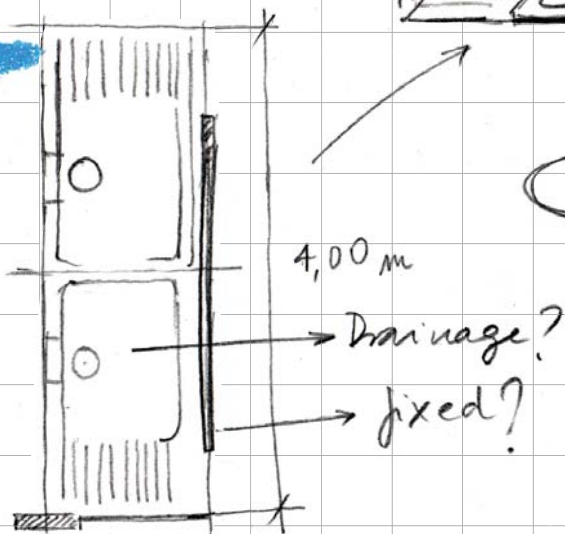

4,00 m

Drainage?

fixed?

Shower tray
4 m long solution?

Hidrobox

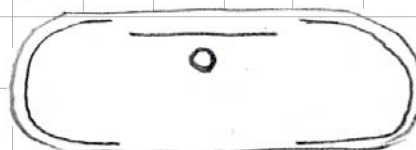
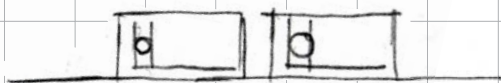

UNA SOLUCIÓN A LA MEDIDA DE LOS PROYECTOS MÁS SINGULARES

Pensada para apoyar a los creadores de soluciones singulares en espacios de ducha, ofreciendo nuevas posibilidades en el mundo del diseño, la serie de platos de ducha Unique ostenta el máximo grado de personalización, el proceso de fabricación es tratado individualmente.

A TAILOR-MADE SOLUTION FOR THE MOST SINGULAR PROJECTS

Devised to aid the creators of singular solutions within the shower area, offering new possibilities to the world of design, the Unique shower tray series offers the highest possible level of personalization, where the manufacturing phase is treated on an individual basis.

UNE SOLUTION A LA HAUTEUR DES PROJETS LES PLUS SINGULIERS

Collection développée pour les créateurs de solutions singulières dans l'espace douche, offrant de nouvelles possibilités dans le monde de la conception. La série offre un degré maximal de personnalisation, le processus de fabrication sera traité individuellement.



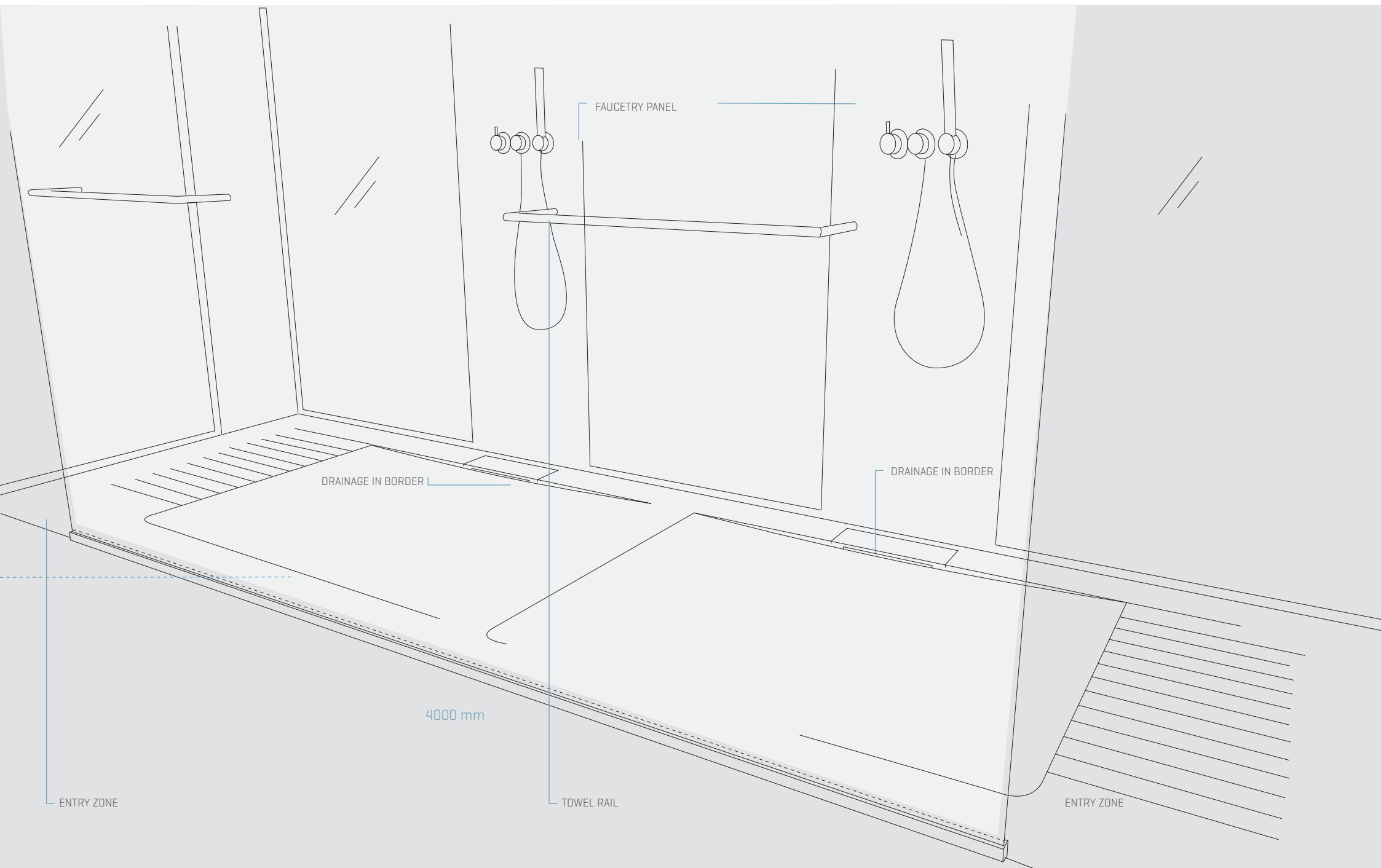

FAUCETRY PANEL

DRAINAGE IN BORDER

DRAINAGE IN BORDER

4000 mm

ENTRY ZONE

TOWEL RAIL

ENTRY ZONE

SOLUCIÓN PERSONALIZADA PARA FORMATOS EXTRA GRANDES

El cliente diseña el plato de ducha indicando la forma exterior, la posición que desea para el desaguado del plato y la estética, a partir de esas indicaciones Hidrobox realiza un plano técnico apto para ser fabricado. El producto puede realizarse en materiales como Scene® y Marmek®, en textura lisa y diferentes colores. El formato del plato de ducha puede estar entre 70 y 130 cm de ancho y entre 70 y 230 cm de largo, ampliables a 400 cm mediante dos unidades coordinadas.

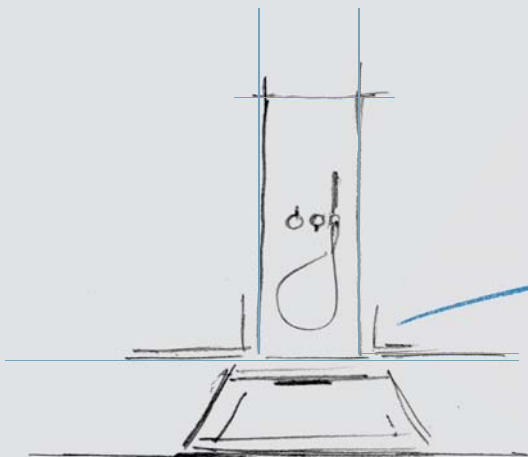

A PERSONALIZED SOLUTION FOR EXTRA-LARGE FORMATS

The client designs the shower tray, indicating its outer form, the position of the drainage and the aesthetic aspects as desired. From the client's requirements Hidrobox then drafts a technical drawing, suitable for use in manufacturing. The product can be manufactured using materials such as Scene and Marmek, with a smooth texture surface and different colours. The shower tray's format can be anything from 70 to 130 cm wide and from 70 to 230 cm long, extendible to 400 cm through the union of two closely coordinated units.

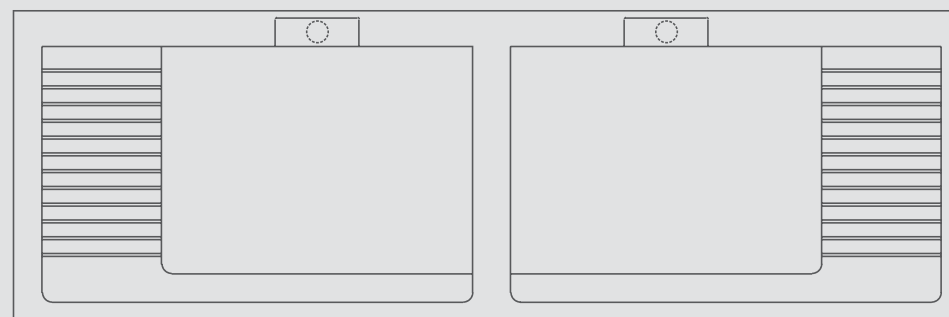

4000 mm

FINAL SOLUTION

Tras el estudio del proyecto, se ha optado por desaguado en borde y situar ranurados en las zonas de entrada.

After a careful assessment of the project, border-mounted drainage and grooves placed in the entry zones have been selected.

Suite à l'étude du projet, le client a opté pour une évacuation en bordure du receveur et l'ajout de rainures sur les zones d'entrée de la douche.



Drainage system:
in border







UNIQUE 130x400

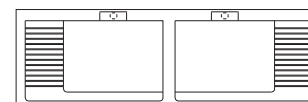

blanco | acabado textura lisa
 white | smooth texture finish
 blanc | finition texture lisse



desagüe en borde
 drainage in border
 évacuation sur le bord

Scene

SOLUCIÓN PARA FORMATOS EXTRA GRANDES

Para alcanzar soluciones de plato de ducha en **longitudes superiores a 230 cm y hasta 400 cm** puede diseñar un espacio en base a dos unidades ensamblables de plato de ducha. Las dos unidades, de hasta 200 cm de longitud, se suministrarán independientes entre sí, pero coordinando su diseño para un correcto ensamblaje en destino.

A SOLUTION FOR EXTRA-LARGE FORMATS

In order to achieve a solution regarding shower trays measuring more than 230cm and up to 400cm in length, an area based on the assembly of two units may be designed. The two units, up to 200cm in length, are supplied independently of one another, however, their design is closely coordinated to guarantee a correct assembly at their final location.

SOLUTION POUR DIMENSIONS EXTRA-LARGES

Pour atteindre des solutions de receveurs de douche avec des longueurs supérieures à 230 cm et ce jusqu'à 400 cm, il est possible de créer un espace basé sur l'union de deux unités assemblables de receveur de douche. Les deux unités qui pourraient atteindre 200 cm de long seront livrées indépendamment l'une de l'autre, mais coordonnant leur conception pour un assemblage correcte sur place.

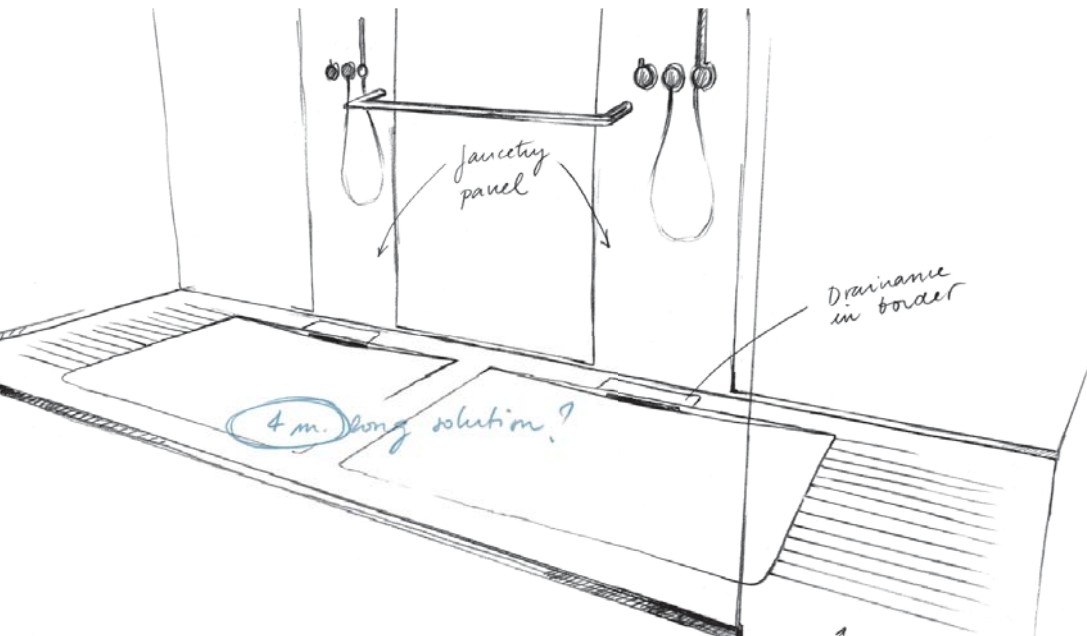

Ejemplo de necesidad de solución extra grande de 100x325 cm.
Example: Requirements for an extra-large 100x325cm solution.
Exemple de besoin de solution extra-large de 100x325 cm.

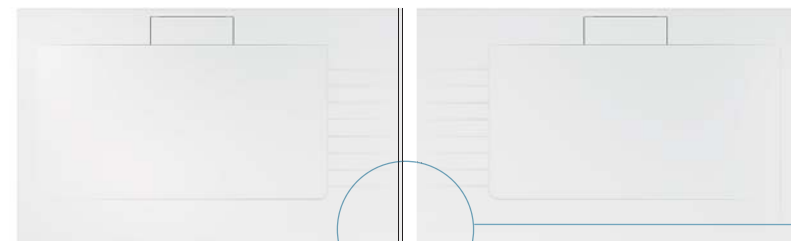
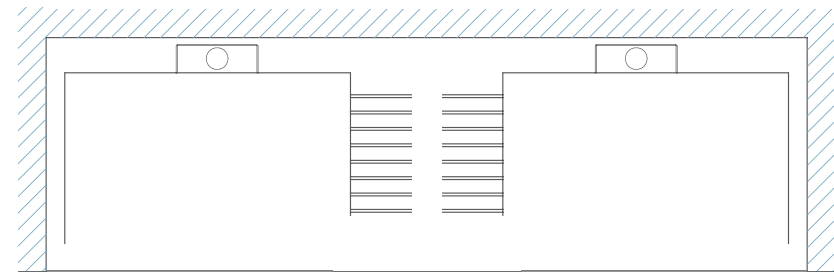

1

2



ENSAMBLAJE

Pestañas de ensamblaje inferior en Unidad 1 y superior en Unidad 2 que determinan la secuencia de instalación. La junta final de unión puede ser marcada a la vista, rejuntada mediante materiales genéricos, o disimulada mediante el uso de los mismos materiales del plato de ducha.

ASSEMBLY

Inferior assembly joints in unit 1 and upper assembly joints in unit 2 determine the sequence in which the units are to be installed. The joint between the two units may be visible, joined using generic materials or dissimulated through the use of the same material as the shower tray.

ASSEMBLAGE

Onglets d'assemblage inférieur en unité 1 et supérieur en unité 2 déterminant la séquence d'installation. Le joint final de l'union peut être visible en utilisant un matériel de jointure classique ou bien être dissimulé par le biais de l'utilisation du même matériau que le receveur de douche.

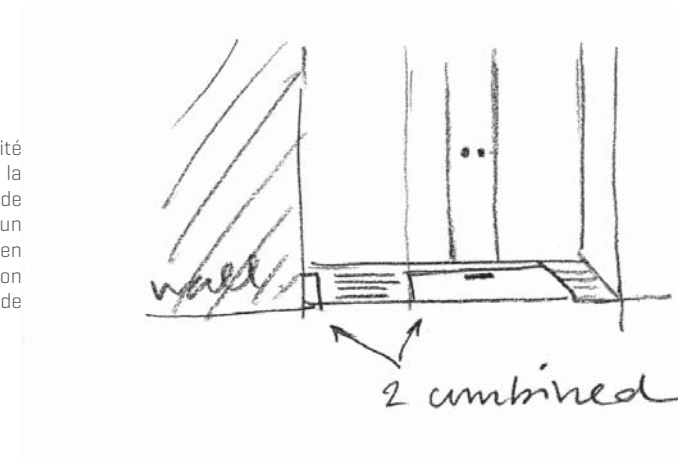

UNIQUE 100x325

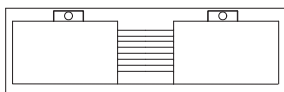

2 unidades coordinadas
2 matching units
2 unités coordonnées

	blanco	acabado textura lisa
	white	smooth texture finish
	blanc	finition texture lisse

desagüe en borde
drainage in border
évacuation sur le bord

Scene





UNIQUE 130x180

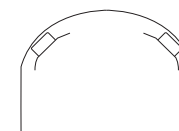

blanco | acabado textura lisa
white | smooth texture finish
blanc | finition texture lisse



desagüe en borde
drainage in border
évacuation sur le bord

Scene

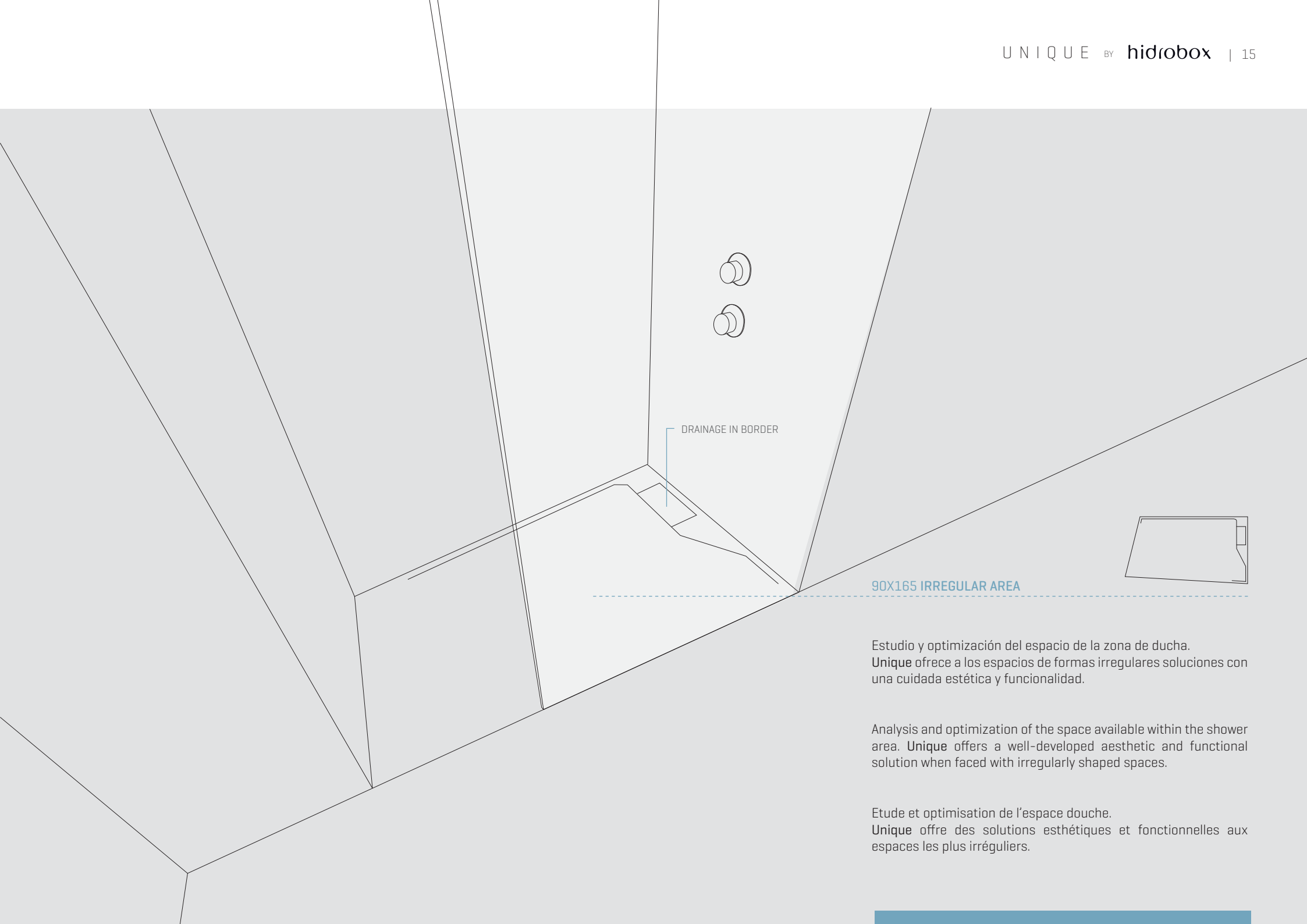

DRAINAGE IN BORDER

90X165 IRREGULAR AREA

Estudio y optimización del espacio de la zona de ducha. **Unique** ofrece a los espacios de formas irregulares soluciones con una cuidada estética y funcionalidad.

Analysis and optimization of the space available within the shower area. **Unique** offers a well-developed aesthetic and functional solution when faced with irregularly shaped spaces.

Etude et optimisation de l'espace douche. **Unique** offre des solutions esthétiques et fonctionnelles aux espaces les plus irréguliers.

UNIQUE 90x120

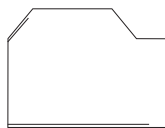

blanco | acabado textura lisa
white | smooth texture finish
blanc | finition texture lisse

desagüe a pared
wall drain
évacuation murale

Scene





UNIQUE 90x165

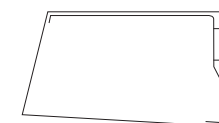

blanco | acabado textura lisa
white | smooth texture finish
blanc | finition texture lisse



desagüe en borde
drainage in border
évacuation sur le bord

Scene



Tapa cuadrada Inox o del mismo color que el plato de ducha.
Square cover, stainless-steel or same color as shower tray.
Grille carrée Inox ou de la même couleur que le receveur.





Tapa redonda Inox o del mismo color que el plato de ducha.
Round cover, stainless-steel or same color as shower tray.
Grille ronde Inox ou de la même couleur que le receveur.

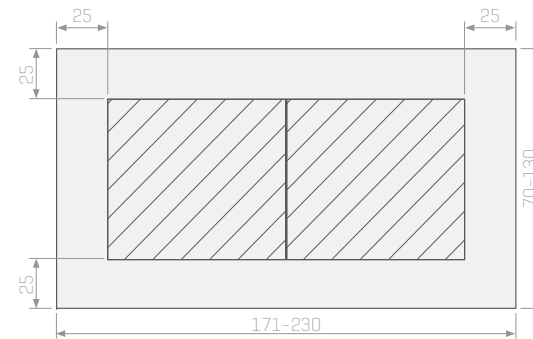
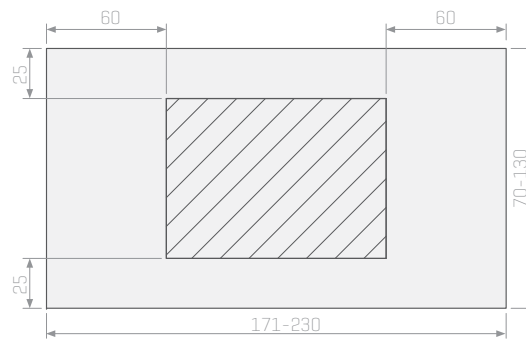
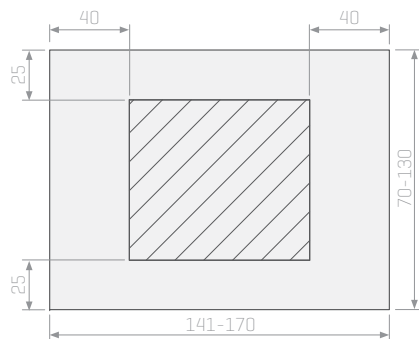
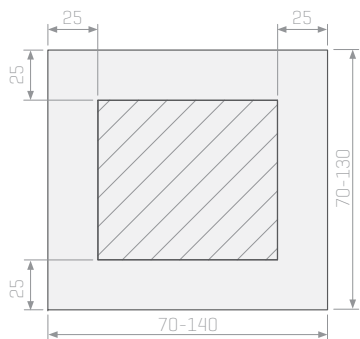

Tapa rectangular del mismo material que el plato de ducha.
Rectangular cover in same material as shower tray.
Cache bonde rectangulaire de la même matière que le receveur de douche.

Zonas en las que es posible posicionar el desagüe/s según la dimensión del plato de ducha.
Areas where the drainage(s) may be positioned, according to the dimensions of the shower tray
Zones sur lesquelles il est possible de positionner les évacuations selon la dimension du receveur de douche



 Área para la ubicación del desagüe en interior.
Area where drainage may be positioned in interior of shower tray.
Zone de positionnement pour l'évacuation intérieure.

1 plato con 2 desagües en interior.
1 shower tray complete with 2 interior drainages.
1 receveur avec 2 évacuations intérieures.

DESAGÜE A PARED | WALL DRAINS | EVACUATION MURALE Suministro no incluido / Not supplied / Fourniture Non comprise

Desaguado a pared para canaleta de ducha, como por ejemplo:

Wall inlet channel drainage, e.g.

Évacuation murale pour caniveau de douche, exemple:



Viega Advantix Vario [art. 736736]





Geberit Duofix [art. 111.593.00.1]

Distancias a respetar para la ubicación del canal de desaguado.

Distances that must be observed in relation to the position of the inlet channel and the corners of the shower tray.

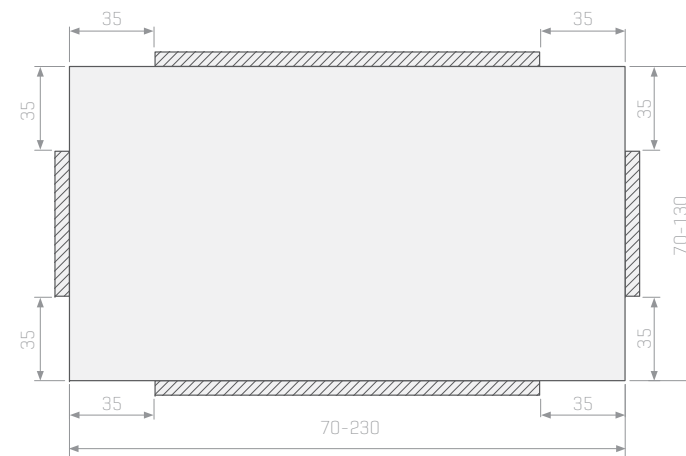
Distances à respecter par rapport aux extrémités pour le positionnement du canal



 Área para la ubicación del desagüe a pared.
Area for wall drain to be positioned.
Zone de positionnement de l'évacuation murale.

DESAGÜE EN BORDE | BORDER-MOUNTED DRAINAGE | EVACUATION SUR LE BORD



Tapa rectangular del mismo material que el plato de ducha.

Rectangular drain cover, same material and finish as shower tray.
Cache bonde rectangulaire de la même matière que le receveur de douche.

Distancias a respetar para la ubicación del canal de desaguado.

Distances that must be observed in relation to the position of the inlet channel and the corners of the shower tray.

Distances à respecter par rapport aux extrémités pour le positionnement du canal

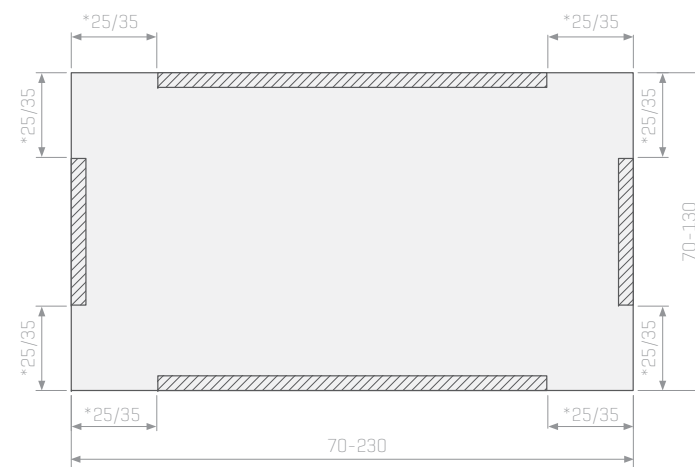

 Área para la ubicación del desagüe en borde.
Area for border-mounted drainage.
Zone de positionnement de l'évacuation sur le bord

25 en largos entre 70 y 140 cm./ *35 en largos entre 141 y 230 cm.
25 for lengths between 70 and 140 cm / 35 for lengths between 141 and 230 cm.
25 sur les longueurs entre 70 et 140cm / 35 sur les longueurs entre 141 et 230 cm.

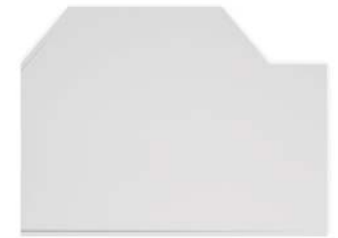
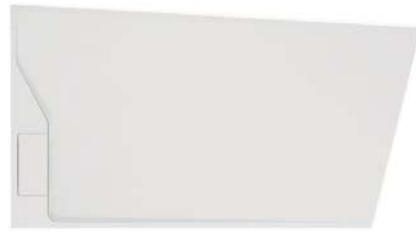

ALTURA | HEIGHT | HAUTEUR

 30 mm

INSTALACIÓN | INSTALLATION | INSTALLATION



Sobre pavimento
Onto paving
A posé



Encastrado
Built-in
Encastré

ACABADO SUPERFICIAL | SURFACE FINISH
FINITION SUPERFICIELLE

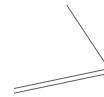

Acabado textura lisa
Smooth texture finish
Finition texture lisse

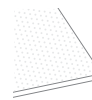

Superficie antideslizante.
Tratamiento Antislip Clase 3 [ENV 12633] | C [DIN 51097] | PN24 [XP P05-011]. Incluido en Marmek®, opcional en Scene®

Slip resistant surface.
Clase 3 [ENV 12633] | C [DIN 51097] | PN24 [XP P05-011]
Anti-slip Treatment. Included in Marmek®, optional in Scene®

Finition antidérapante.
Traitement Antislip Classe 3 [ENV 12633] | C [DIN 51097] | PN24 [XP P05-011]. Inclus en Marmek®, optionnel en Scene®

MATERIAL | COLOR | MATERIAL | COLOUR | MATERIAU | COULEUR

Scene



BLANCO
WHITE
BLANC

marmek

COLORES | COLOURS | COULEURS STANDARD

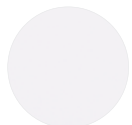

BIANCO



PIETRA



CREME



BEIGE



CAPPUCINO



TERRA



CACAO



GRIS



CEMENT



STEEL



IRON



OMBRA



GRAPHITE

COLORES | COLOURS | COULEURS SPECIAL



RAL* / NCS*

Los colores se suministran en gama mate. No se aceptan pedidos de colores brillo o efectos metálicos puesto que se perderían características en el producto. Ante cualquier duda, infórmese en nuestro servicio de atención al cliente.

The colours supplied are from the matt range. Orders for gloss or metallic finishes are not accepted as they could alter the products characteristics. In the event of any doubt, please contact our customer service department.

Les couleurs sont fournies en finition mate. Les finitions brillantes et métalliques ne sont pas acceptées car elles altèrent les caractéristiques du produit. En cas de doute, contacter notre service d'Attention Clientèle.

hidrobox[®]
live the innovation

ABSARA INDUSTRIAL S.L.
Partida Saloni s/n
12130 Sant Joan de Moró
Castellón [Spain]

España + 34 964 105 176
comercial@absaraindustrial.com

France 0 811 66 57 41
france@absaraindustrial.com

Export + 34 964 657 272
export@absaraindustrial.com

Deutschland +49 01 807 808 777
deutschland@absaraindustrial.com

www.hidrobox.com

