

## Swap City

### Scene

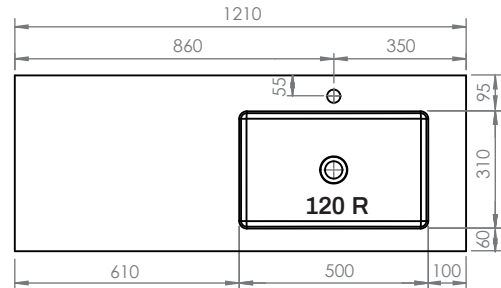

### Kromat

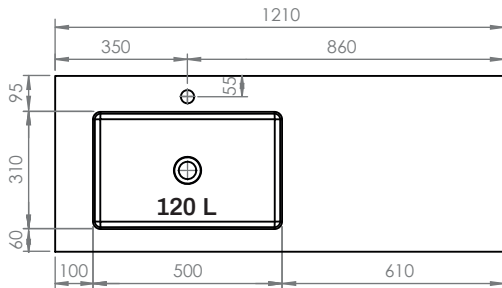
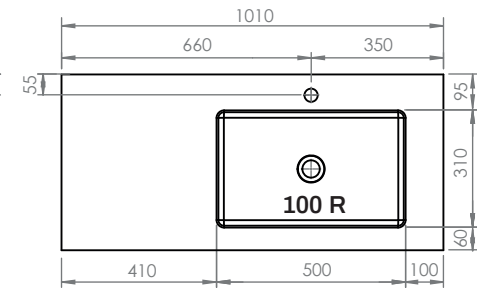
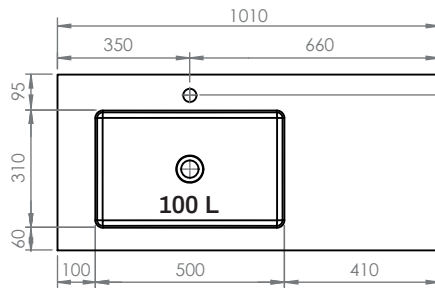
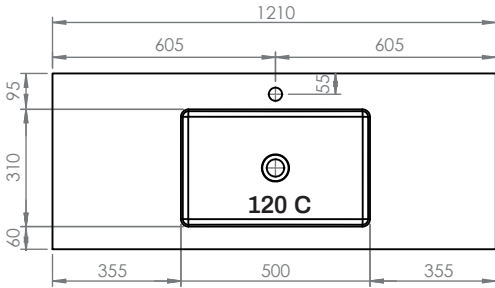
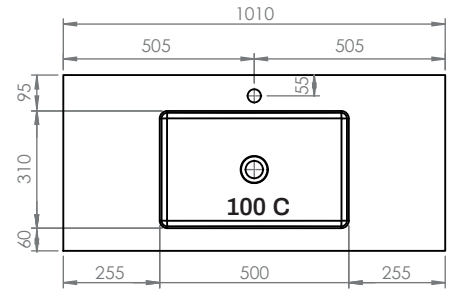
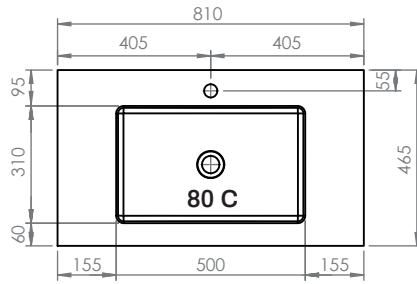
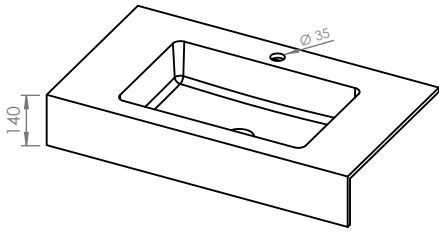
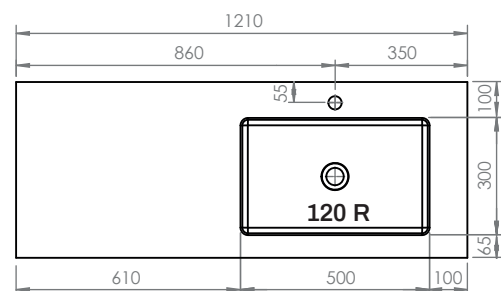
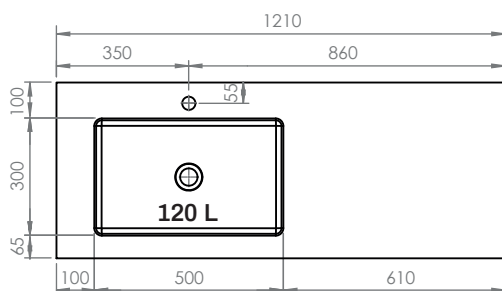
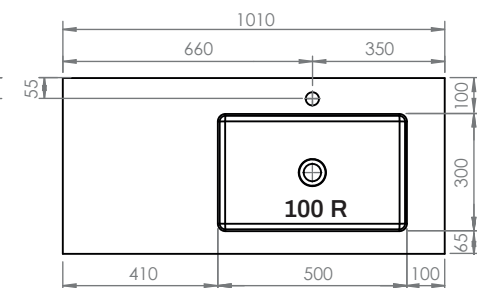
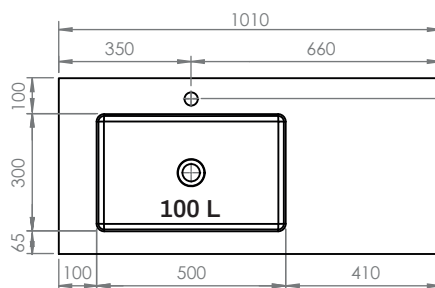
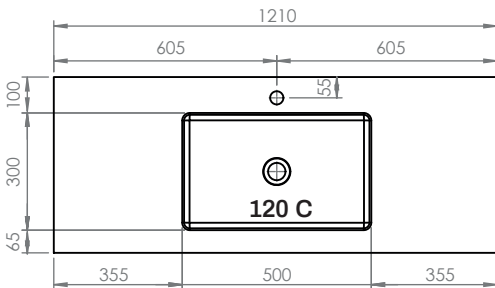
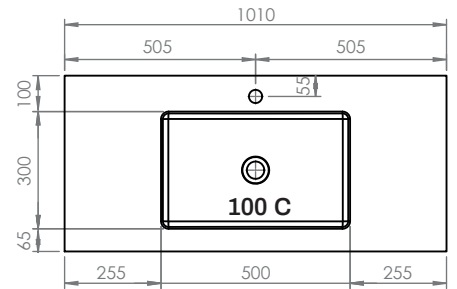
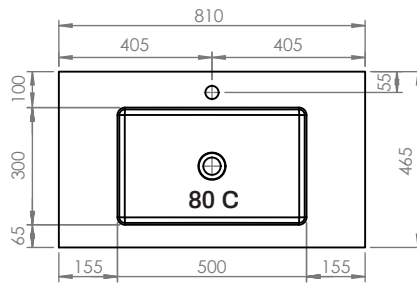
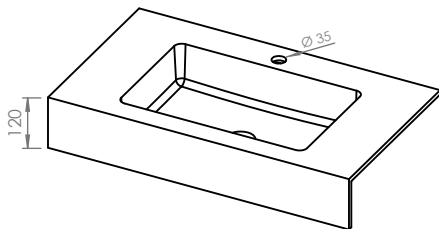

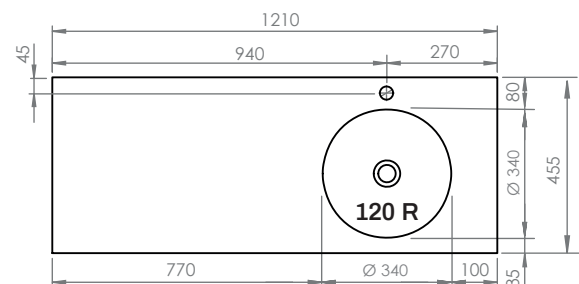
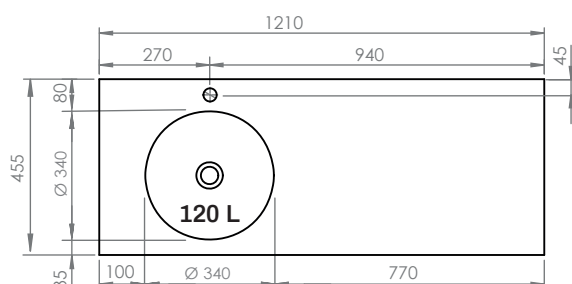
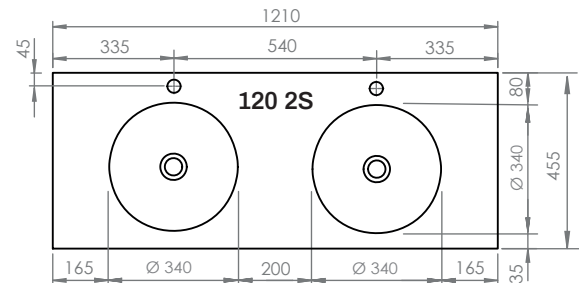
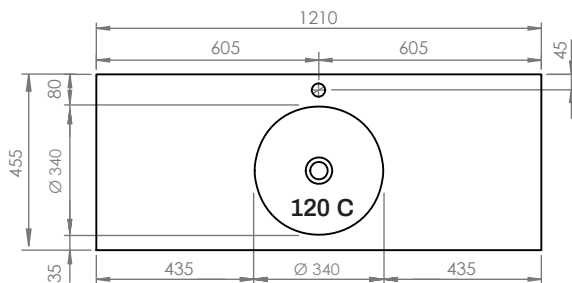
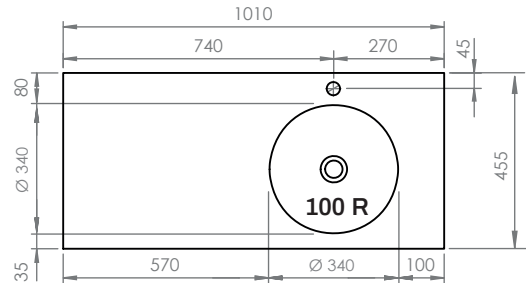
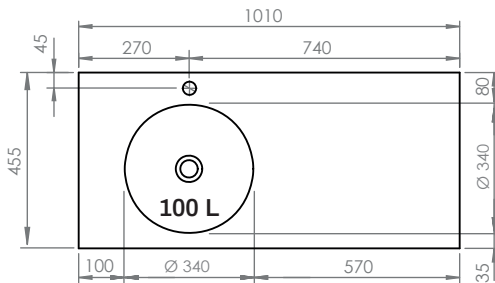
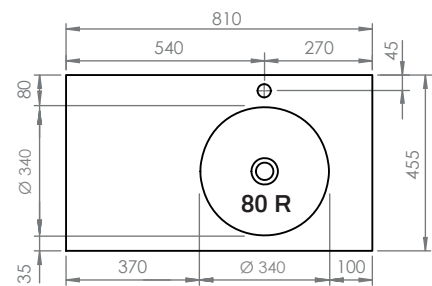
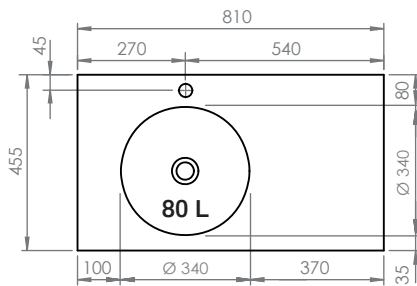
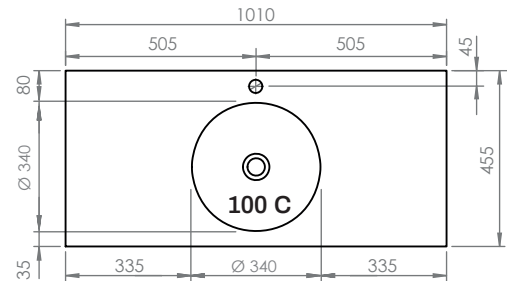
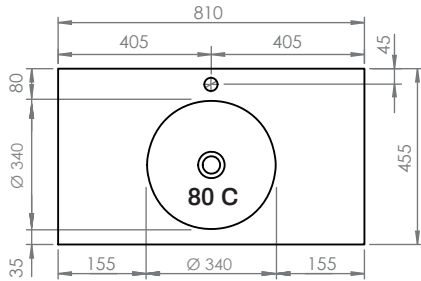
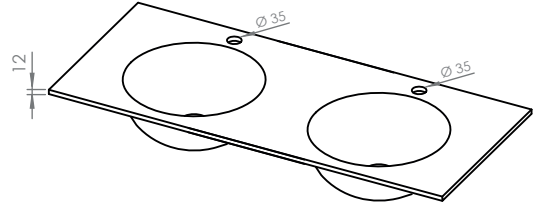
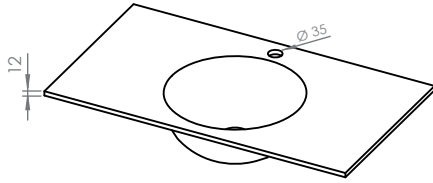

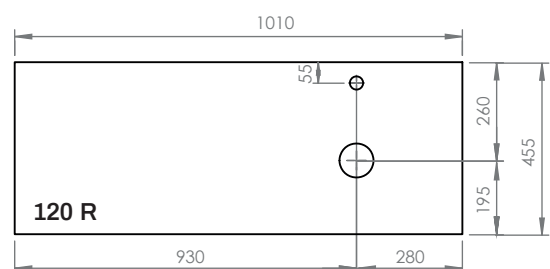
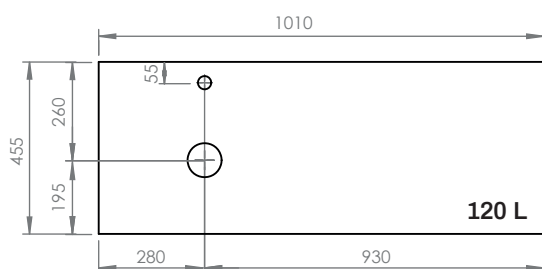
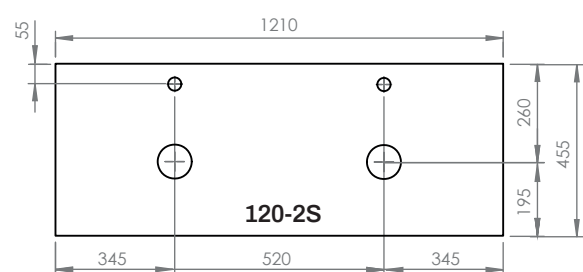
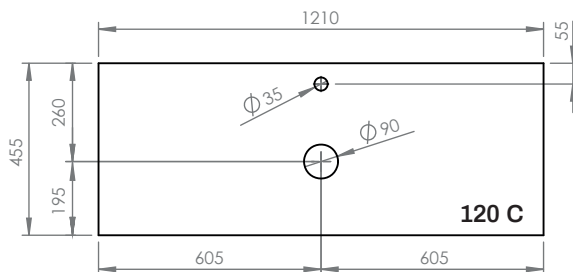
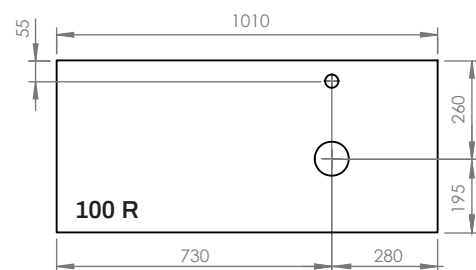
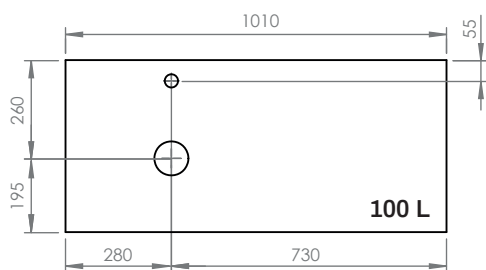
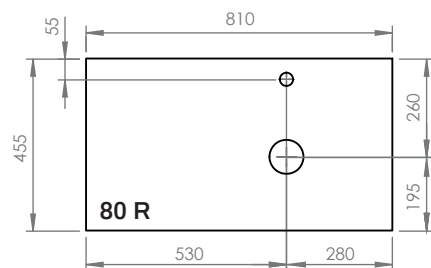
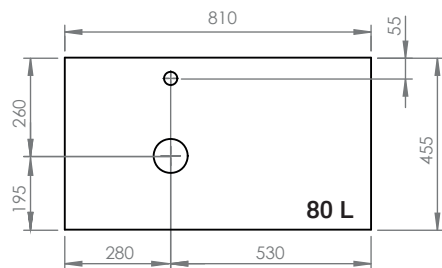
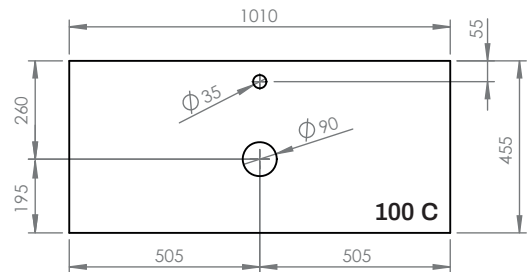
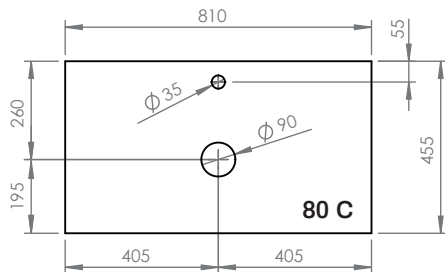
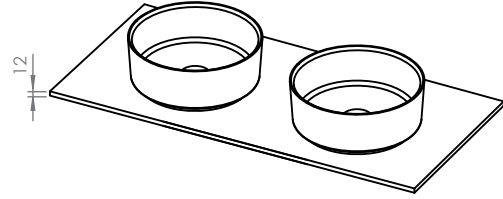
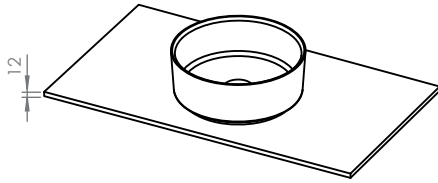

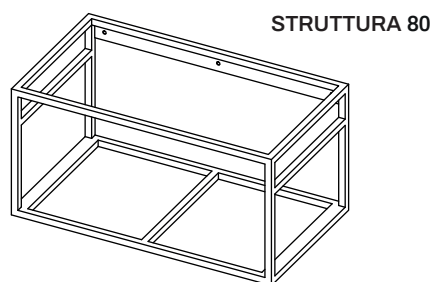

STRUTTURA 80

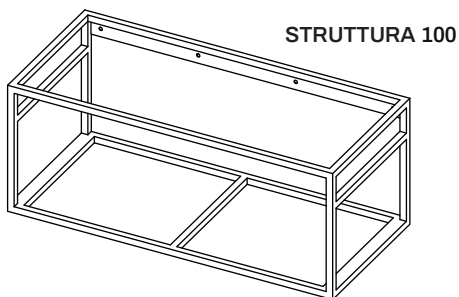
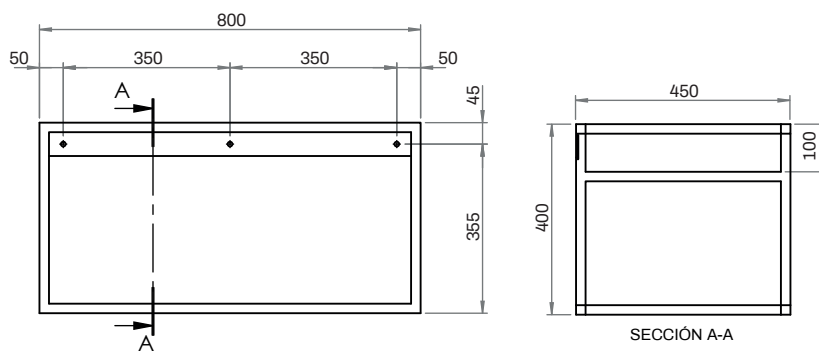

STRUTTURA 100

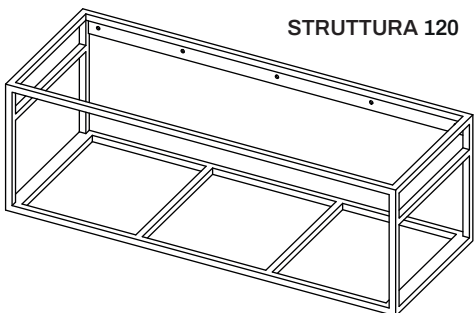
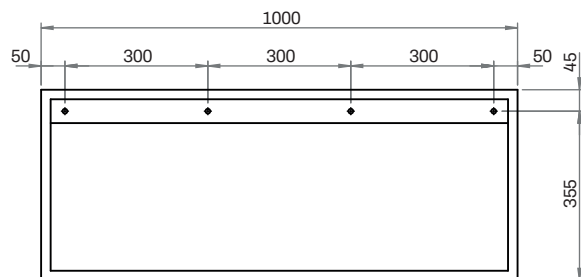

STRUTTURA 120

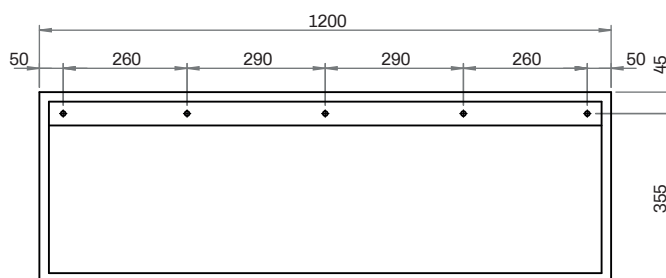

### Istruzioni per la posa

1

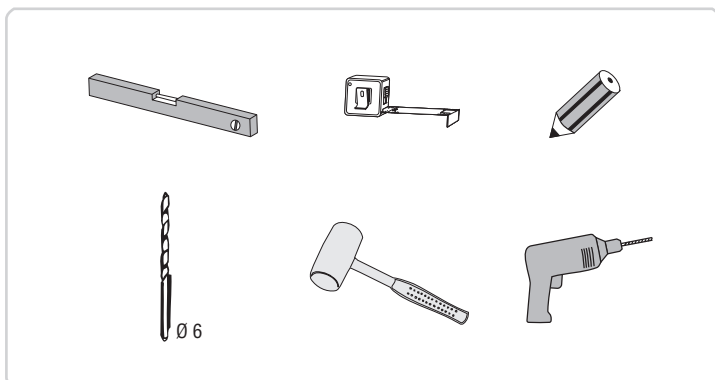

2

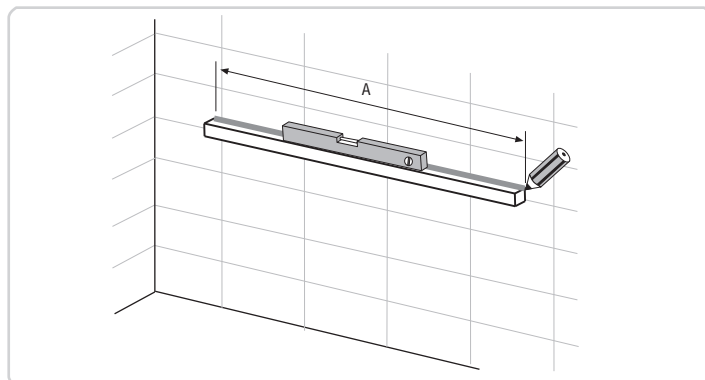

3.1

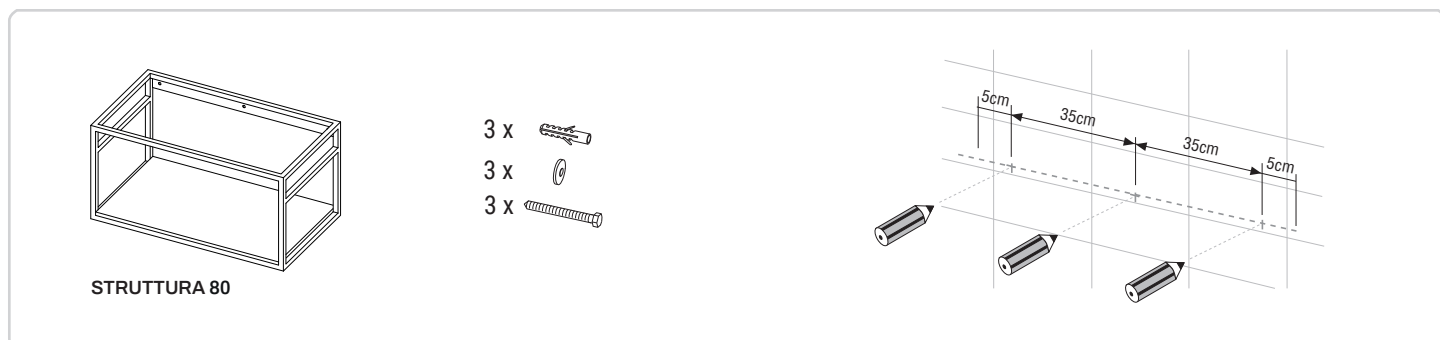

STRUTTURA 80

## 3.2

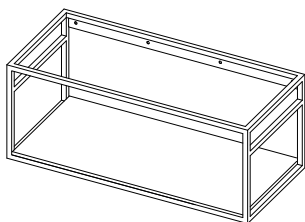

STRUTTURA 100

- 4 x
- 4 x
- 4 x

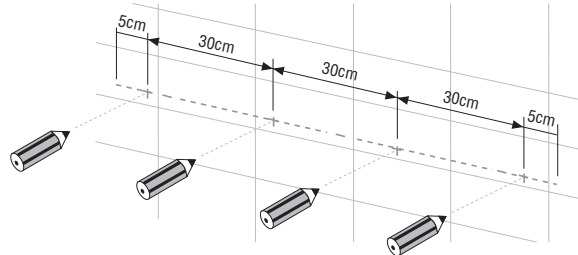

## 3.3

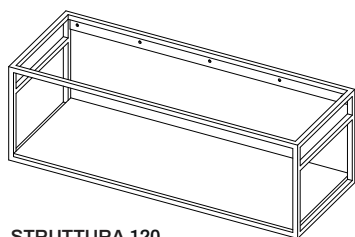

STRUTTURA 120

- 5 x
- 5 x
- 5 x

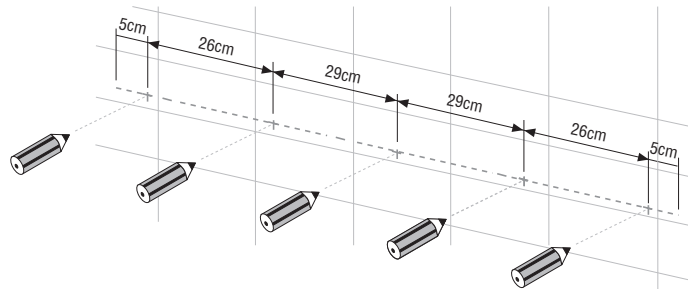

## 4

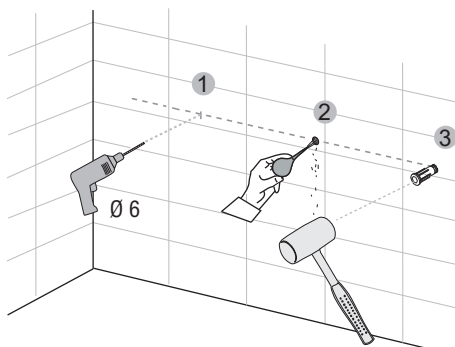

## 5

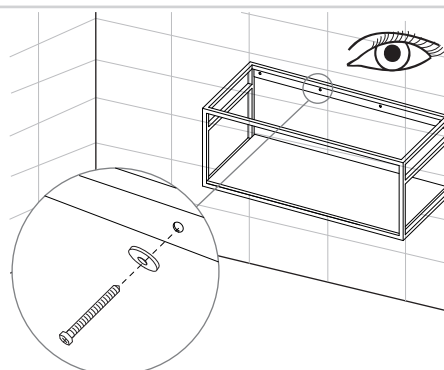

## 6.1 Swap City / Swap Esfera

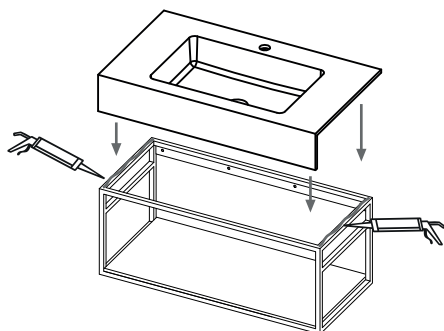

## 6.2 Swap Spot

